

VHF UHF Helical Filter Specification Sheet

Customer Name		Temwell's Part No.	K2B-400M-10M
Approval No. /dated	20401004DC	Customer's Part No.	
Work Instruction No.	20401004DC	Date	Jan.09.2004
<input type="checkbox"/> Buyer Print name		<input type="checkbox"/> Temwell,s print name	
Case Name	7H2	Case size :	
Terminator Type	B		

* Pin Position (Pin Connection) diagram as following

(B) Type

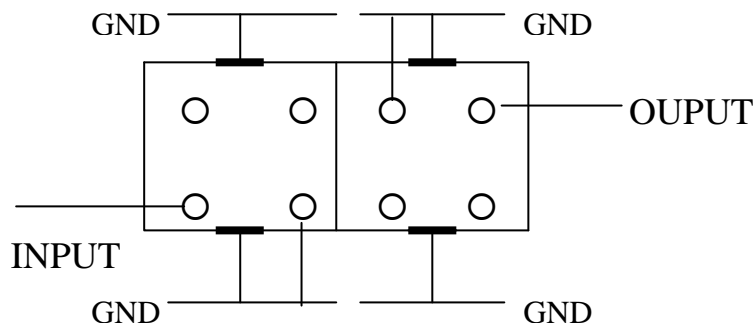

(Bottom View)

(3) Electric Charasteric

Item	Specify	Performance
Center Freq.(Fo) +/- 0.5 %	400 MHz	400 MHz
Insertion Loss	2.0 dB	1.28 dB
-3 dB Bandwidth	10 MHz	19 MHz
Sensentivity (Attenuation)	Fo - 50 MHz	Typ. 30 dB
	Fo + 50 MHz	Typ. 20 dB
	Fo - () MHz	Typ. dB
	Fo +() MHz	Typ. dB
Return Loss	Min. 12 dB	34 dB
Ripple	< 1 dB	dB
Group Delay	ns	ns
Impedance	In / Out : 50 Ω	In / Out : 50 Ω

4. Temperature Condition:

Operating Temperature	0 °C ~ +60 °C
Storage Temperature	-20 °C ~ +70 °C

Approval	Supervisor	Designer	Aperture size
	C.S.Chang	P.H.Ching	7H2(4*6.5)(6.56) 7H046RB4

TEMWELL CORPORATION

Performance-K2B-400M-10M

20401004DC

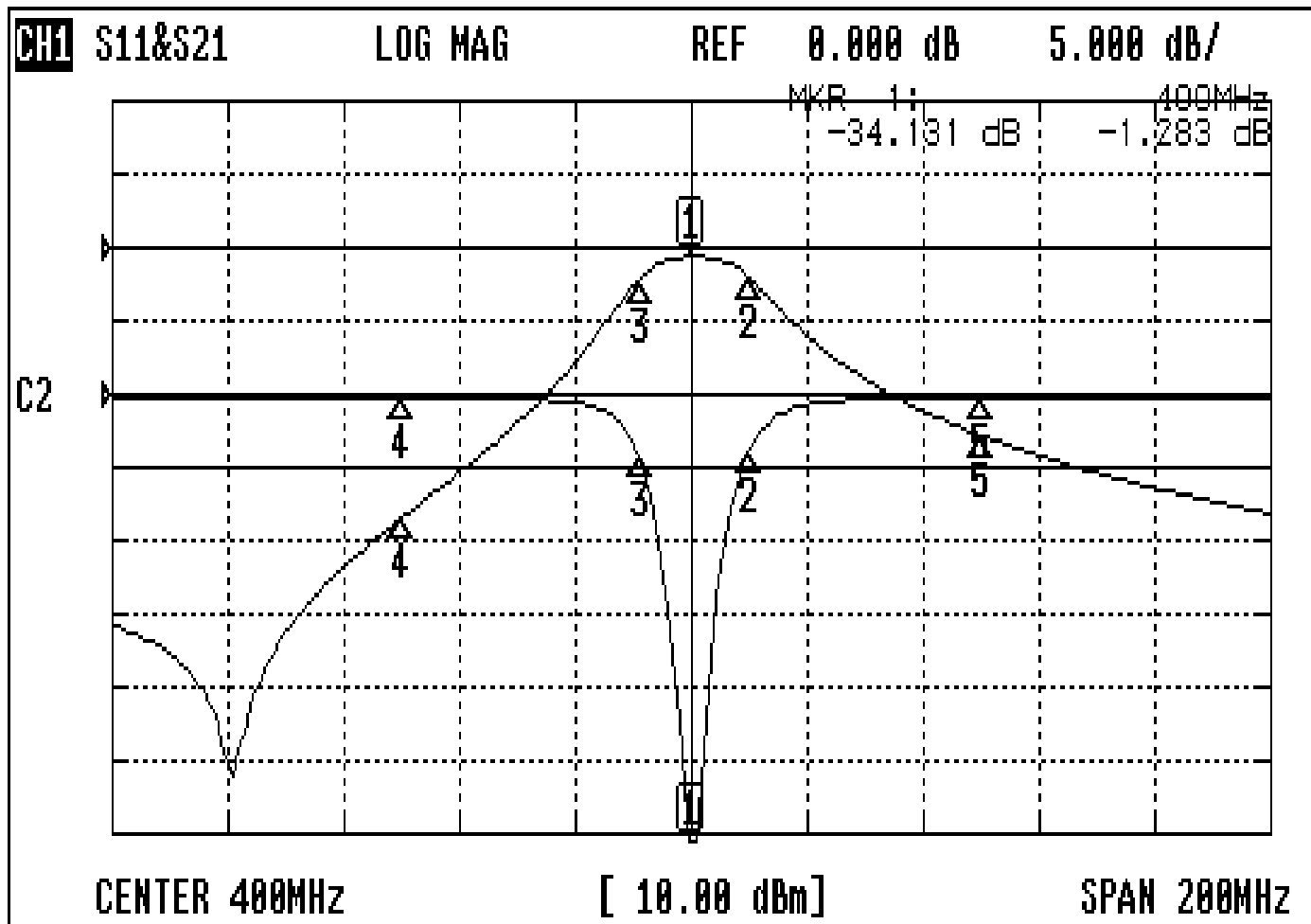

CH1 MARKER LIST

1:	400.000MHz	-34.131 dB	-1.283 dB
2:	410.166MHz	-3.805 dB	-4.205 dB
3:	391.166MHz	-4.357 dB	-4.332 dB
4:	350.000MHz	-0.198 dB	-36.941 dB
5:	450.000MHz	-0.209 dB	-25.652 dB
6:			
7:			
8:			
9:			
10:			